

P/N. BH001

ALL DIMENSIONS IN
MM UNLESS STATED

THE CONTENTS OF THIS DRAWING ARE COPYRIGHT AND SHOULD NOT BE
REPRODUCED WITHOUT THE PERMISSION OF DJH ENGINEERING

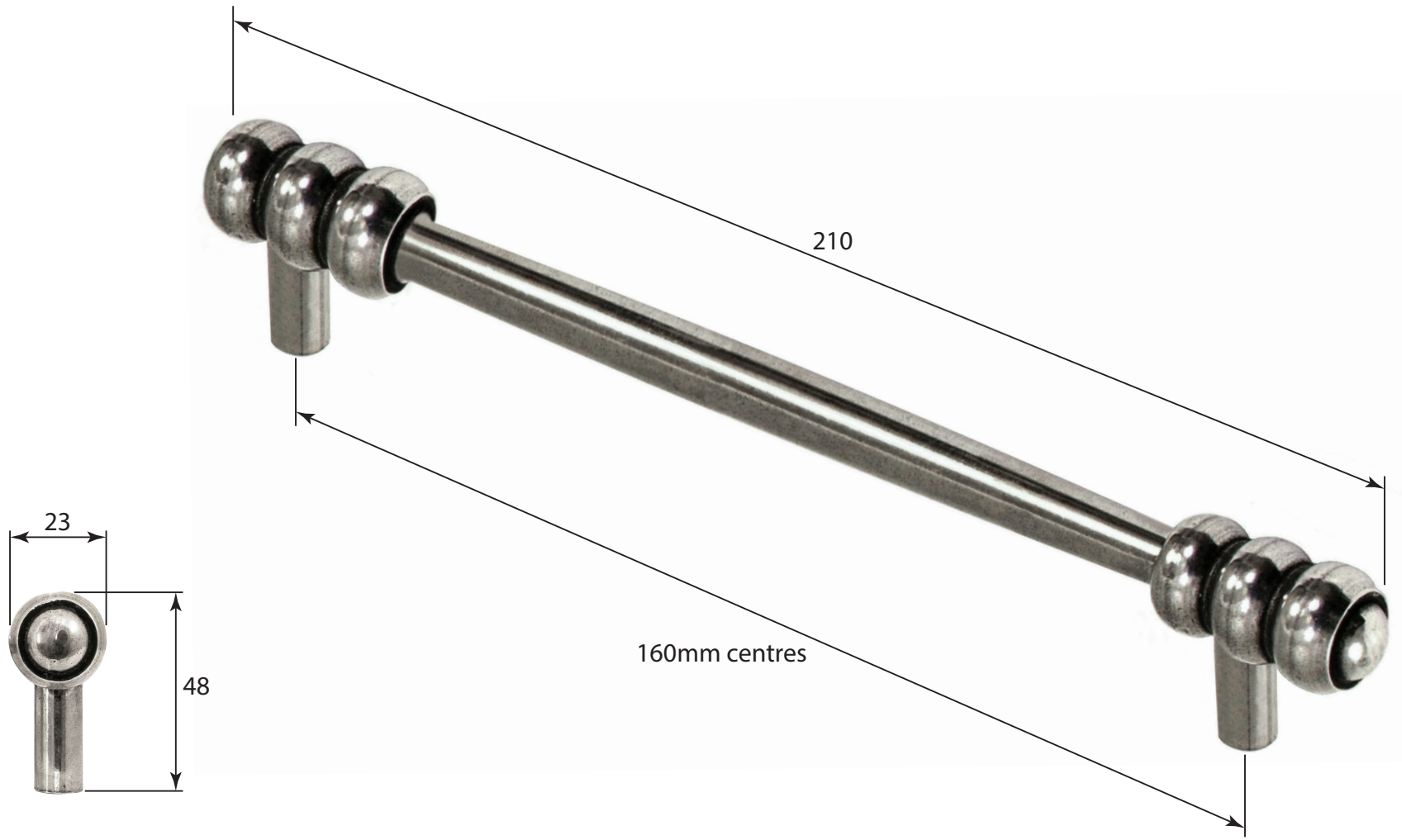

					QTY	
			DESCRIPTION		DRG.	D. Urwin
			BH001 Heaton Bar Handle (160mm centres).		DATE	06/09/18
1	06/09/18		LT REF.	H:\Finesse & Stonebridge Handle Hardware\Finesse\Dim Dwgs\BH001.pdf	SCALE	N/A
ISSUE	DATE	REVISION	MATL.	Pewter	CODE	BH001