

P/N. BH014

ALL DIMENSIONS IN  
MM UNLESS STATED

THE CONTENTS OF THIS DRAWING ARE COPYRIGHT AND SHOULD NOT BE  
REPRODUCED WITHOUT THE PERMISSION OF DJH ENGINEERING

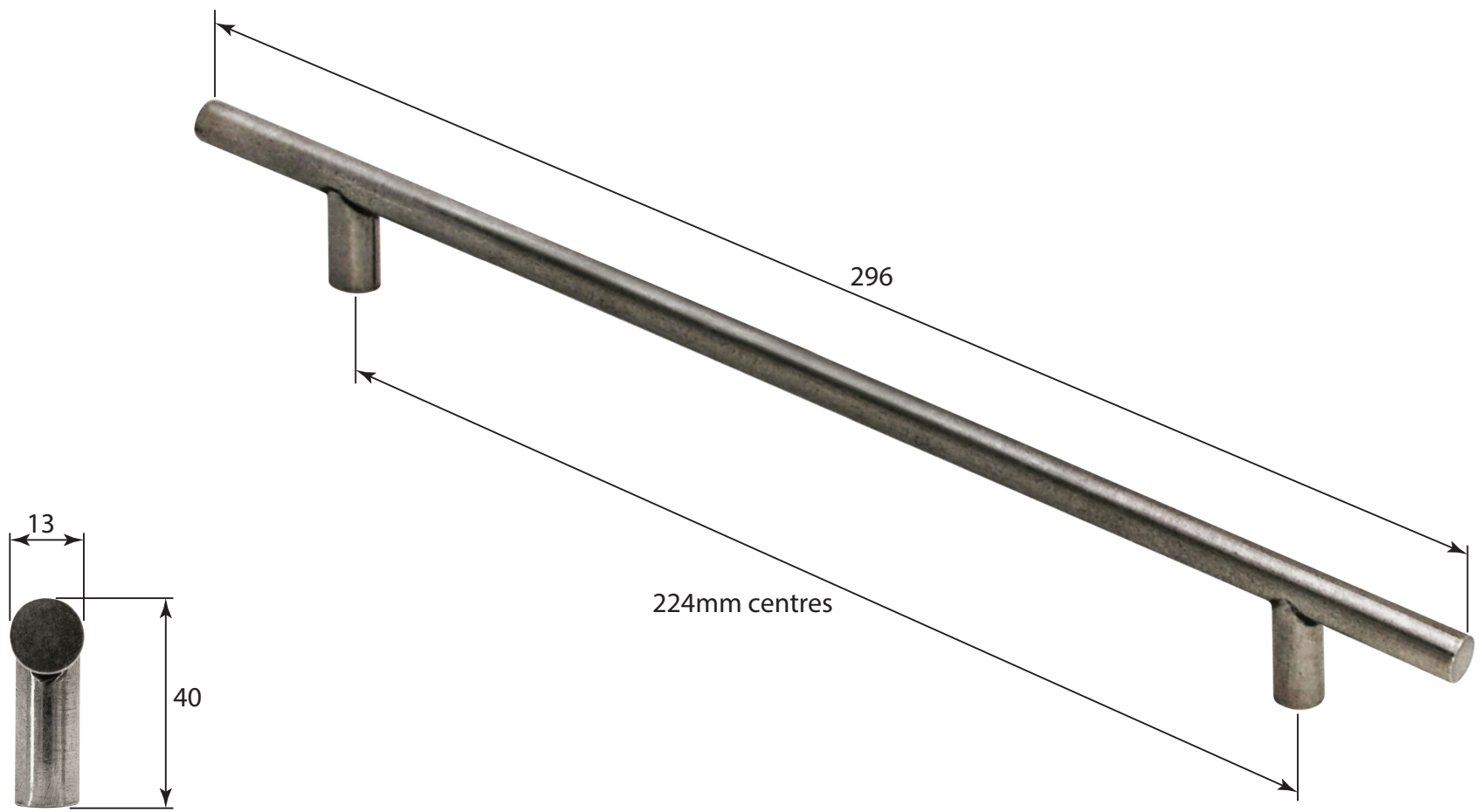

						QTY	
				<b>DESCRIPTION</b>		<b>DRG.</b>	D. Urwin
				BH014 Brompton Bar Handle (224mm centres).		<b>DATE</b>	06/09/18
1	06/09/18		<b>LT REF.</b>	H:\Finess & Stonebridge Handle Hardware\Finesse\Dim Dwgs\BH014.pdf		<b>SCALE</b>	N/A
<b>ISSUE</b>	<b>DATE</b>	<b>REVISION</b>	<b>MATL.</b>	Pewter		<b>CODE</b>	BH014