

P/N. BH018
 ALL DIMENSIONS IN MM UNLESS STATED
 THE CONTENTS OF THIS DRAWING ARE COPYRIGHT AND SHOULD NOT BE REPRODUCED WITHOUT THE PERMISSION OF DJH ENGINEERING

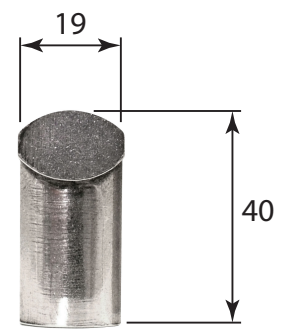
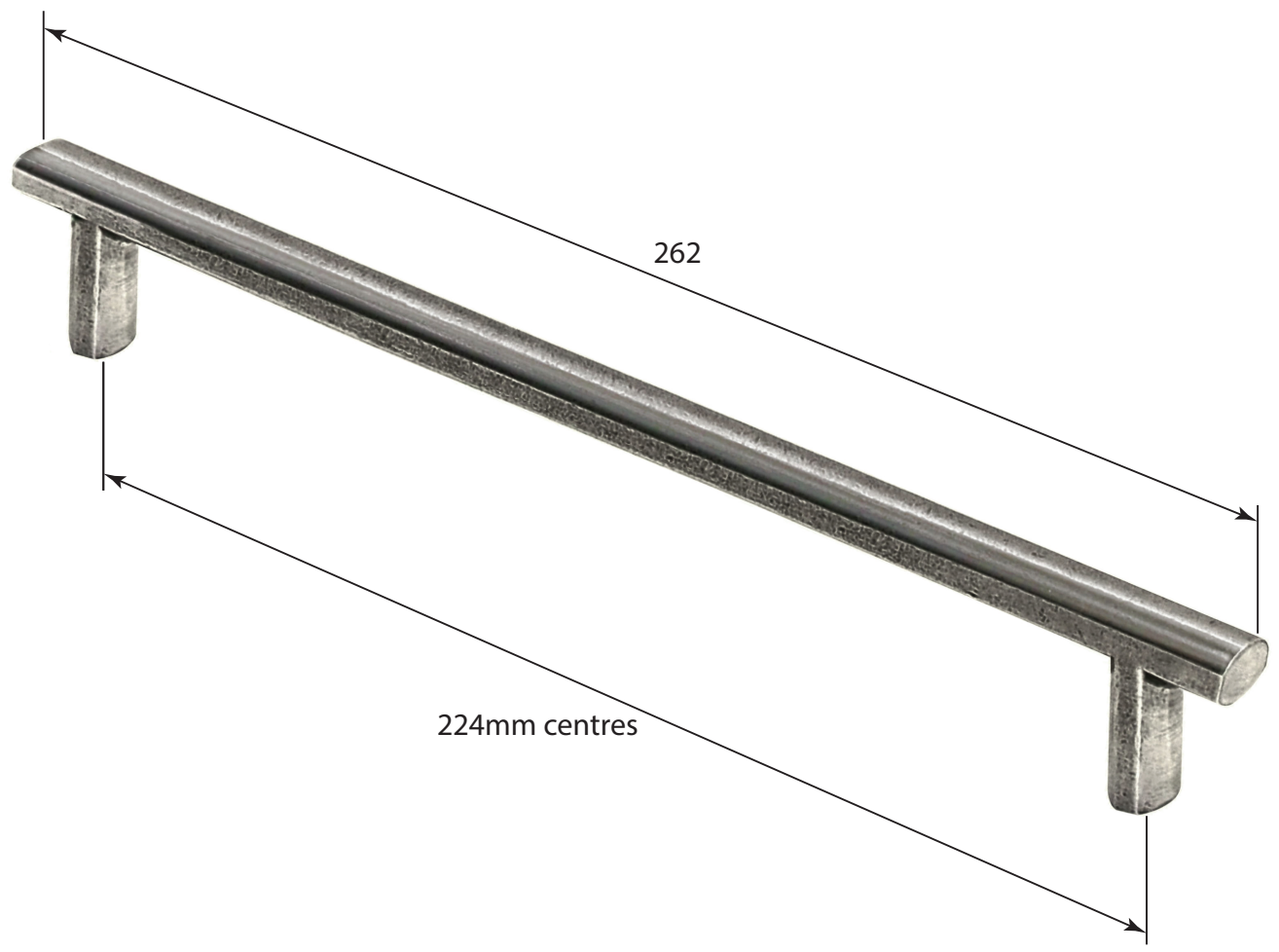

					QTY	
			DESCRIPTION		DRG.	D. Urwin
			BH018 Croxdale Bar Handle (224mm centres).		DATE	06/09/18
1	06/09/18		LT REF.	H:\Finess & Stonebridge Handle Hardware\Finesse\Dim Dwgs\BH018.pdf	SCALE	N/A
ISSUE	DATE	REVISION	MATL.	Pewter	CODE	BH018