

P/N. BH034

ALL DIMENSIONS IN
MM UNLESS STATED

THE CONTENTS OF THIS DRAWING ARE COPYRIGHT AND SHOULD NOT BE
REPRODUCED WITHOUT THE PERMISSION OF DJH ENGINEERING

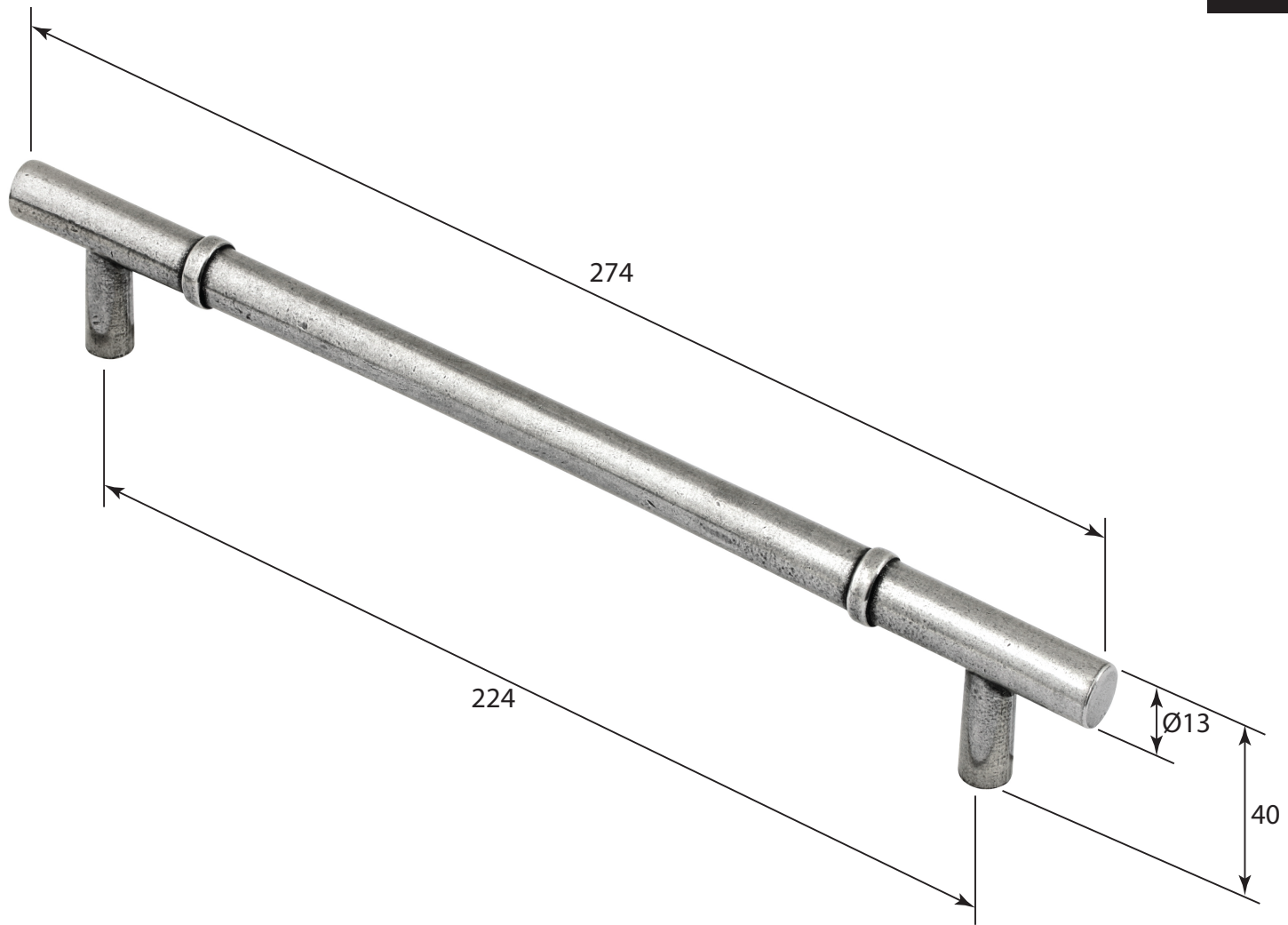

						QTY	
				DESCRIPTION		DRG.	A.Liddle
				BH034 Quebec Pull Handle (224mm centres)		DATE	08/08/18
1	08/08/18		LT REF.	H:\Finesse & Stonebridge Handle Hardware\Finesse\Dim Dwgs\BH034.pdf		SCALE	N/A
ISSUE	DATE	REVISION	MATL.	Pewter		CODE	BH034