

P/N. FD528

ALL DIMENSIONS IN  
MM UNLESS STATED

THE CONTENTS OF THIS DRAWING ARE COPYRIGHT AND SHOULD NOT BE  
REPRODUCED WITHOUT THE PERMISSION OF DJH ENGINEERING

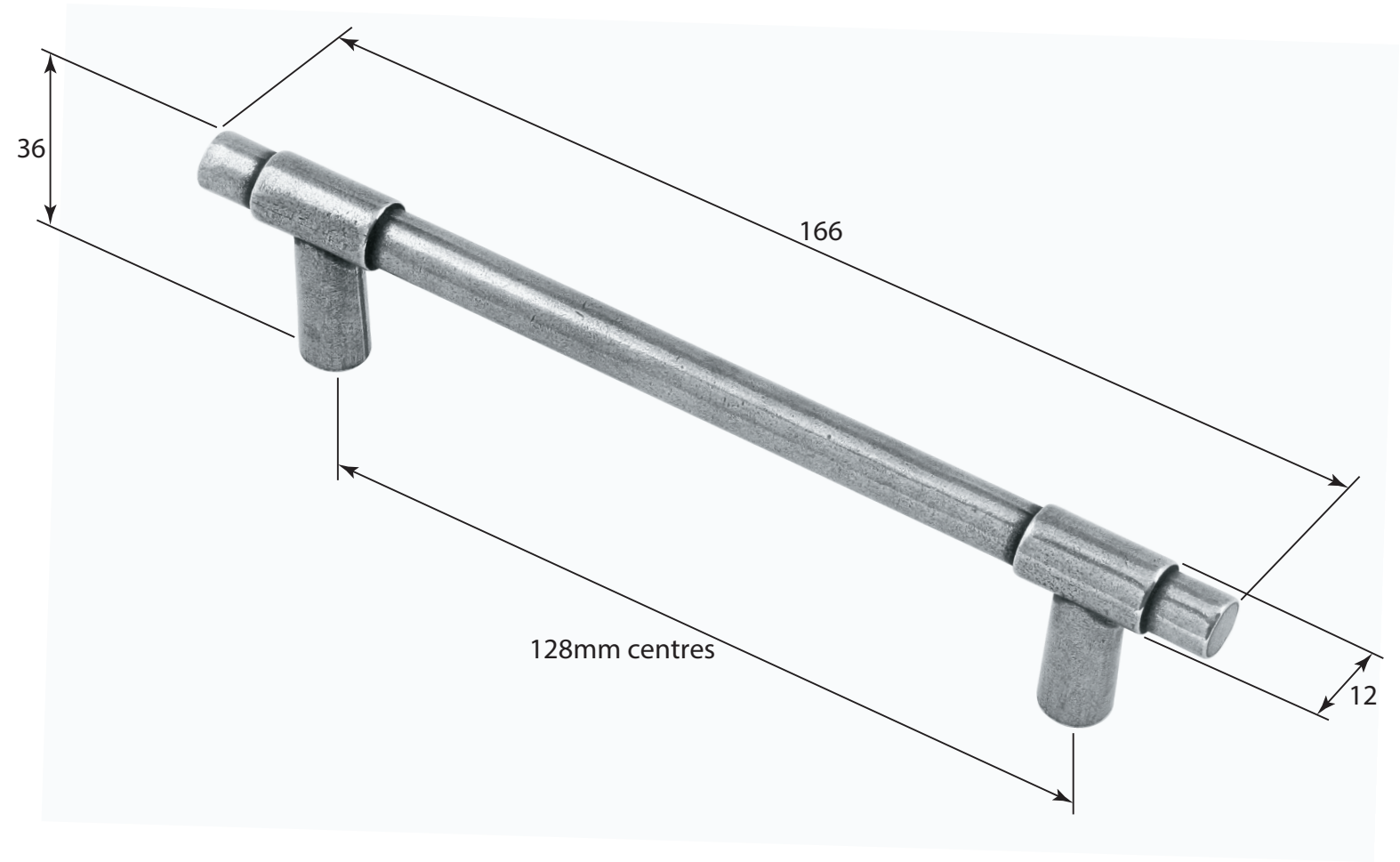

						QTY	
				<b>DESCRIPTION</b>		<b>DRG.</b>	A. Liddle
				FD528 Farrow Pull Handle (128mm centres)		<b>DATE</b>	13/08/18
1	13/08/18		<b>LT REF.</b>	H:\Finess & Stonebridge Handle Hardware\Finesse\ Dim Dwgs\FD528.pdf		<b>SCALE</b>	N/A
<b>ISSUE</b>	<b>DATE</b>	<b>REVISION</b>	<b>MATL.</b>	Pewter		<b>CODE</b>	FD528