

P/N. FD593

ALL DIMENSIONS IN
MM UNLESS STATED

THE CONTENTS OF THIS DRAWING ARE COPYRIGHT AND SHOULD NOT BE
REPRODUCED WITHOUT THE PERMISSION OF DJH ENGINEERING

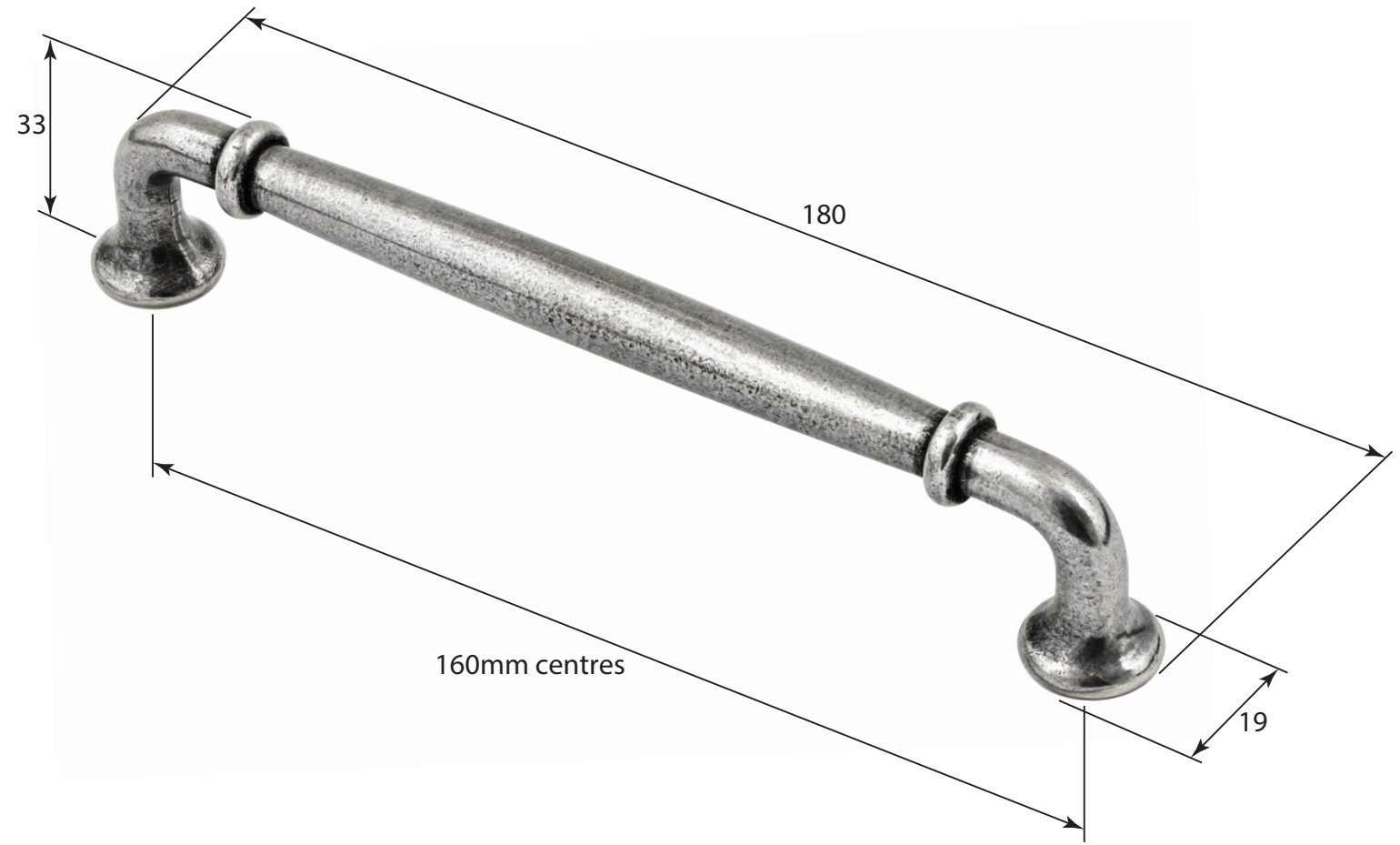

					QTY	
			DESCRIPTION	DRG.	A. Liddle	
			FD593 Chester Pull Handle (160mm centres)	DATE	16/08/18	
1	16/08/18		LT REF.	H:\Finess & Stonebridge Handle Hardware\Finesse\ Dim Dwgs\FD593.pdf	SCALE	N/A
ISSUE	DATE	REVISION	MATL.	Pewter	CODE	FD593